

KOHLER®

OWNER'S MANUAL

Generator



Read this manual carefully before operating this machine.

PRO 2.8 i

7VU-28199-L1

WARNING

The engine exhaust from this product contains chemicals known to the State of California to cause cancer, birth defects or other reproductive harm.

KOHLER

 **Read this manual carefully before operating this machine. This manual should stay with this machine if it is sold.**

INTRODUCTION

Congratulations on your purchase of your new Kohler.

This manual will provide you with a good basic understanding of the operation and maintenance of this machine.

If you have any questions regarding the operation or maintenance of your machine, please consult a Kohler portable dealer.

**PRO 2.8 i
OWNER'S MANUAL
First edition, January 2014
© 2014 Reprinted by Kohler Co. under license.
All rights reserved.
Any reproduction or unauthorized use
without the written permission of
the copyright holder is expressly prohibited.
Printed in Japan.**

IMPORTANT MANUAL INFORMATION

Particularly important information is distinguished in this manual by the following notations.



This is the safety alert symbol. It is used to alert you to potential personal injury hazards. Obey all safety messages that follow this symbol to avoid possible injury or death.

WARNING

A WARNING indicates a hazardous situation which, if not avoided, could result in death or serious injury.

NOTICE

A NOTICE indicates special precautions that must be taken to avoid damage to the machine or other property.

TIP

A TIP provides key information to make procedures easier or clearer.

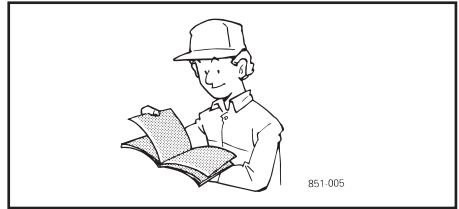

WARNING

PLEASE READ AND UNDERSTAND THIS MANUAL COMPLETELY BEFORE OPERATING THE MACHINE.

TIP

- Kohler continually seeks advancements in product design and quality. Therefore, while this manual contains the most current product information available at the time of printing, there may be minor discrepancies between your machine and this manual. If there is any question concerning this manual, please consult a Kohler portable dealer.
- This manual should be considered a permanent part of this machine and should remain with this machine when resold.

* Product and specifications are subject to change without notice.

CONTENTS

SAFETY INFORMATION	1	Fuel cock.....	32
Exhaust fumes are poisonous	2	Fuel tank filter	32
Fuel is highly flammable and poisonous.....	2	G.F.C.I. Receptacle test	33
Engine and muffler may be hot.....	2	TROUBLESHOOTING	34
Electric shock prevention	3	STORAGE	36
Connection notes	4	Drain the fuel.....	36
Connection	4	Engine	37
Extension cord notes	4	EXHAUST EMISSION CONTROL SYSTEM AND COMPONENTS	38
LOCATION OF IMPORTANT LABELS	5	SPECIFICATIONS	39
DESCRIPTION	6	Dimensions	39
Control panel.....	6	Engine	39
CONTROL FUNCTION	7	Generator	39
Oil warning light (red).....	7	CONSUMER INFORMATION	40
Recoil starter.....	7	Identification number records.....	40
Engine switch.....	7	Machine identification	40
Economy control switch	8	WIRING DIAGRAM	41
DC protector.....	8	PRO 2.8 i	41
G.F.C.I. Receptacle	9		
PREPARATION	10		
Fuel	10		
Engine oil	11		
Ground (earth) terminal	12		
PRE-OPERATION CHECK	13		
Pre-operation check.....	13		
OPERATION	14		
Starting the engine.....	14		
Application range	16		
High Altitude Operation	17		
Connection	18		
Battery charging.....	20		
Stopping the engine.....	24		
PERIODIC MAINTENANCE	25		
Maintenance chart	25		
Spark plug inspection	27		
Carburetor adjustment	27		
Engine oil replacement	28		
Muffler screen and spark arrester.....	29		
Air filter	31		

SAFETY INFORMATION

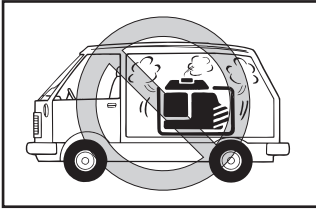

- This generator is not designed for on-board use. Do not use it while installed on the vehicle.



- Do not modify the generator or use it with its parts removed.



- Do not allow children to operate the generator.

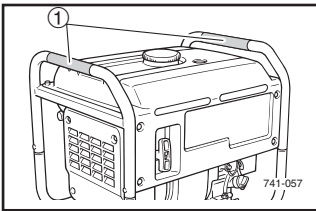

- Be sure to carry the generator only by its carrying handle(s).

① Carrying handle(s) (shaded)

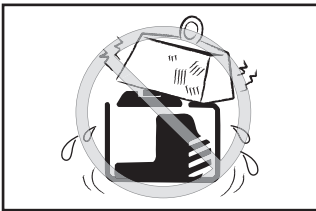

- Do not place any obstacles on the generator.



AE00072

Exhaust fumes are poisonous

- Using a generator indoors **CAN KILL YOU IN MINUTES**. Generator exhaust contains carbon monoxide. This is a poison you cannot see or smell.
- NEVER use inside a home or garage, **EVEN IF** doors and windows are open.
- Only use **OUTSIDE** and far away from windows, doors, and vents.



AE00075

Fuel is highly flammable and poisonous

- Always turn off the engine when refuelling.
- Never refuel while smoking or in the vicinity of an open flame.
- Take care not to spill any fuel on the engine or muffler when refuelling.
- Do not leave the generator inside the vehicle or in the trunk.
- If you swallow any fuel, inhale fuel vapor, or allow any to get in your eye(s), see your doctor immediately. If any fuel spills on your skin or clothing, immediately wash with soap and water and change your clothes.
- When operating or transporting the generator, be sure it is kept upright. If it tilts, fuel may leak from the carburetor or fuel tank.

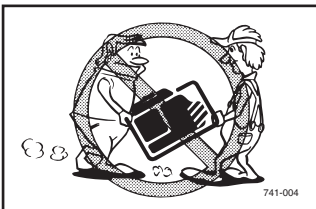
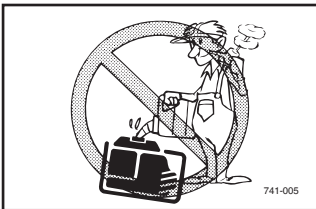

AE00843

Engine and muffler may be hot

- Place the generator in a place where pedestrians or children are not likely to touch the generator.

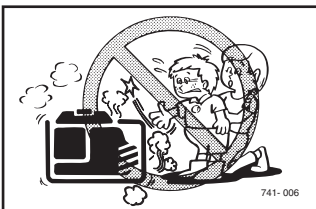

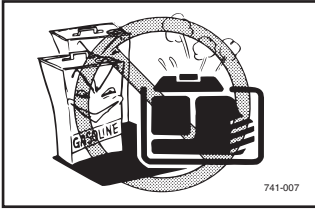

- Avoid placing any flammable materials near the exhaust outlet during operation.

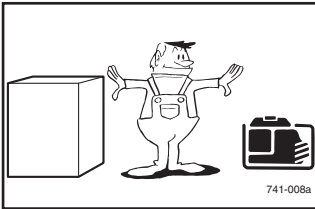

- In order to prevent overheating, ensure adequate airflow by keeping the machine at least 1 m (3 ft) from objects or other equipment.

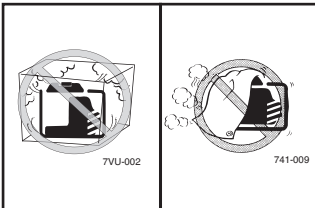

- Do not operate the engine with a dust cover or other objects covering it.

- When covering the generator, be sure to do so only after the engine and muffler have completely cooled down.

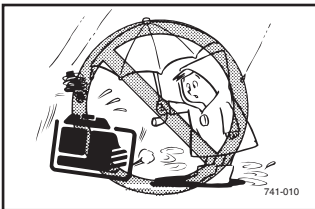

AE00083

Electric shock prevention

- Never operate the engine in rain or snow.

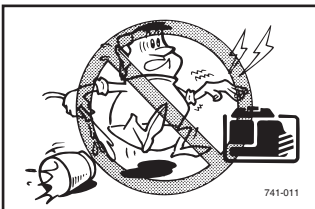

- Never touch the generator with wet hands or electrical shock will occur.

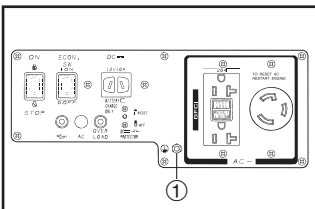

- Connect the Ground (earth) terminal to a ground source. In order to prevent electrical shock, the generator must be grounded when using an electrical device with a ground plug.

① Ground (earth) terminal

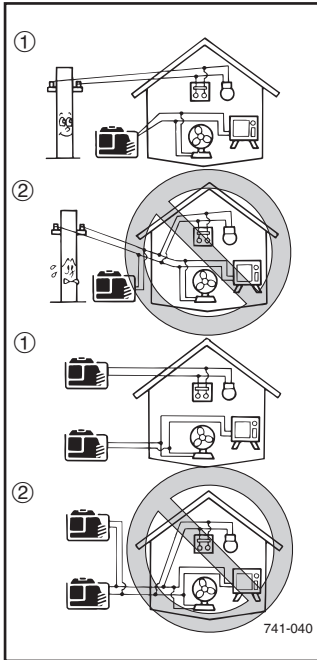

AE00088

Connection notes

- Avoid connecting the generator to commercial power outlet.
- Avoid connecting the generator in parallel with any other generator.

- ① Correct
② Incorrect

AE00091

Connection

⚠ WARNING

Before the generator can be connected to a building's electrical system, a licensed electrician must install an isolation (transfer) switch in the building's main fuse box. The switch is the connection point for generator power and allows selection of generator or main line power to the building. This will prevent the generator from charging the main power line (backfeeding) when the main power supply has failed or has been turned off for line repair. Backfeeding can electrocute or injure line maintenance personnel. Also, generator and building electrical system damage can occur when normal operating power returns if unit is used without an isolation switch.

AE00086

Extension cord notes

Extension cords should be protected by a tough flexible rubber sheath (IEC 245) or the equivalent to withstand mechanical stresses.

LOCATION OF IMPORTANT LABELS

Please read the following labels carefully before operating this generator.

TIP

Maintain or replace safety and instruction labels, as necessary.

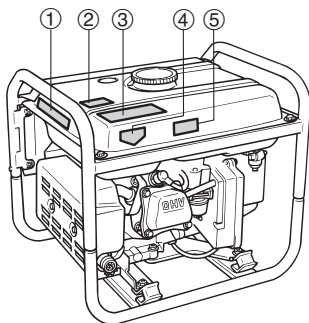

①

EMISSION CONTROL INFORMATION		KOHLER	The air index of this engine is 3	
THIS ENGINE MEETS U.S. EPA EXH / EVP REGS AND CALIFORNIA EXH / EVP SI SORE REGS FOR ****. EMISSION COMPLIANCE PERIOD: **** HOURS EF: *****,***** DISPLACEMENT:****cc EVAP F CARB: *****,***** EVAP F EPA: *****,***** ECS: EM				
			FOR EXTENDED USE Check owner's manual for further details. No other adjustments needed.	

②

⚠ DANGER

Using a generator indoors CAN KILL YOU IN MINUTES.
Generator exhaust contains carbon monoxide.
This is a poison you cannot see or smell.

NEVER use inside a home or garage, EVEN IF doors and windows are open.	Only use OUTSIDE and far away from windows, door, and vents.	

7CO-24877-00

③

<p style="text-align: center;">⚠ WARNING</p> <ul style="list-style-type: none"> Hot parts can cause severe burns. Do not touch generator while operating or just after stopping. Explosive Fuel can cause fires and severe burns. Do not fill fuel tank while generator is hot or running. Electrical shock can cause injury. Do not touch wires while generator is running. Do not connect generator to a building's electrical system unless using an isolation (transfer) switch installed by a certified, licensed electrician. 	<p style="text-align: center;">⚠ ADVERTENCIA</p> <ul style="list-style-type: none"> Las piezas calientes pueden causar quemaduras graves. No toque el generador durante el funcionamiento o inmediatamente después de pararse. La explosión del carburante puede provocar incendios y quemaduras graves. No llene el tanque de combustible mientras el generador esté caliente o funcionando. Las descargas eléctricas pueden provocar lesiones. No toque los cables con el generador en funcionamiento. No conecte el generador al sistema eléctrico de un edificio salvo que lo haga a través de un conmutador de aislamiento (transferencia) instalado por un electricista titulado autorizado.
---	--

④



⑤



PRO 2.8 i

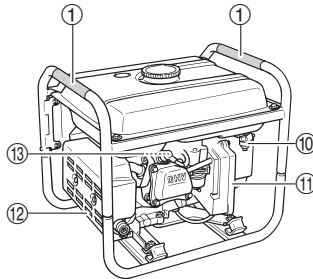
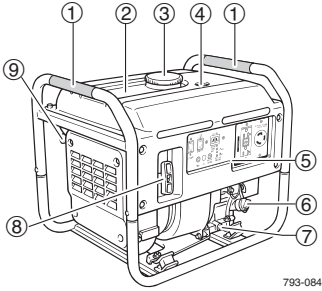

AE00102

DESCRIPTION

- ① Carrying handles (shaded)
- ② Fuel tank
- ③ Fuel tank cap
- ④ Fuel level gauge
- ⑤ Ground (earth) terminal
- ⑥ Oil filler cap
- ⑦ Oil drain bolt
- ⑧ Recoil starter
- ⑨ Choke knob
- ⑩ Fuel cock
- ⑪ Air filter case cover
- ⑫ Muffler
- ⑬ Spark plug

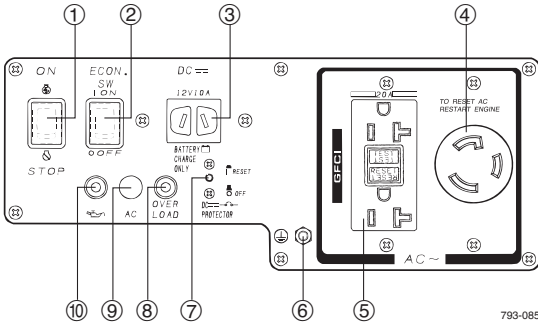

AE00103

Control panel

- ① Engine switch
- ② Economy control switch
- ③ DC receptacle
- ④ AC receptacle
- ⑤ G.F.C.I. receptacle
- ⑥ Ground (earth) terminal
- ⑦ DC protector
- ⑧ Overload indicator light
- ⑨ AC pilot light
- ⑩ Oil warning light

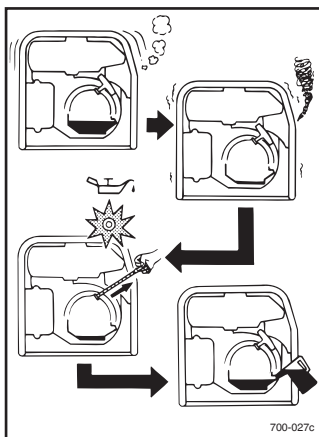

AE00101

CONTROL FUNCTION

AE00111

Oil warning light (red)

When the oil level falls below the lower level, the oil warning light (red) comes on and then the engine stops automatically. Unless you refill with oil, the engine will not start again.

TIP

If the engine stalls or does not start, turn the engine switch to “” and then pull the recoil starter. If the oil warning light flickers for a few seconds, the engine oil is insufficient. Add oil and restart.

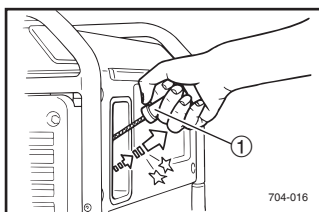

Recoil starter

The recoil starter is used to start the engine. Pull the recoil starter slowly until it is engaged, then pull it briskly.

- ① Recoil starter handle

NOTICE

- Pull the recoil starter handle straight.
- Return the recoil starter handle slowly.
- Do not touch the recoil starter handle while the generator is operating.

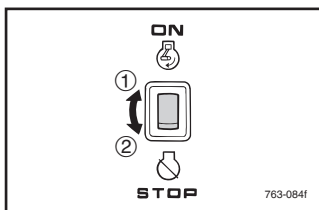

AE00122

Engine switch

The engine switch controls the ignition system.

- ① “” (ON)

Ignition circuit is switched on.
The engine can be started.

- ② “” (STOP)

Ignition circuit is switched off.
The engine will not run.

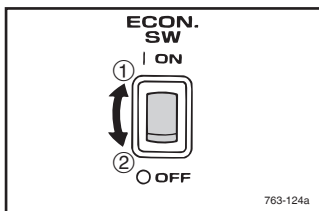

AE00787

Economy control switch

① “1” (ON)

When the economy control switch is turned “1” (ON), the economy control unit controls the engine speed according to the connected load. The results are better fuel consumption and less noise.

② “0” (OFF)

When the economy control switch is turned “0” (OFF), the engine runs at the rated r/min (3,600 r/min) regardless of whether there is a load connected or not.

TIP

The economy control switch must be turned to “0” (OFF) when using electric devices that require a large starting current, such as a compressor or a submersible pump.

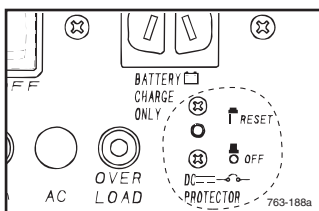

AE00780

DC protector

The DC protector turns off automatically when electric device being connected to the generator is operating and current above the rated flows. To use this equipment again, turn on the DC protector by pressing its button to “1” (RESET).

① “1” (RESET)

Direct current is output. (This is the default position.)

② “0” (OFF)

Direct current is not output.

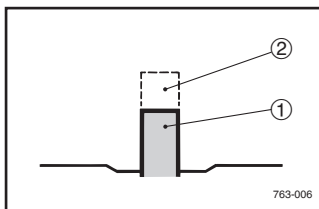

NOTICE

Reduce the load of the connected electric device below the specified rated output of the generator if the DC protector turns off. If the DC protector turns off again, stop using the device immediately and consult a Kohler portable dealer.

AE00848

G.F.C.I. Receptacle

The G.F.C.I. (Ground Fault Circuit Interrupter) shuts off power to the protected receptacles if a ground fault (electrical leak) is detected.

If the reset button pops out, the equipment plugged into the receptacle may be faulty. If this happens, check the equipment carefully. If the equipment appears to be in good condition, press the reset button firmly until a click is heard. This will restore power. If the reset button pops out again, unplug the equipment immediately. Have the equipment inspected and repaired by a qualified repairperson before attempting to use it again.

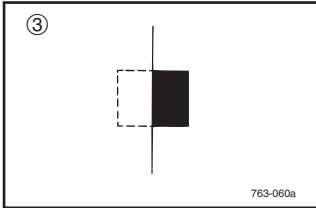
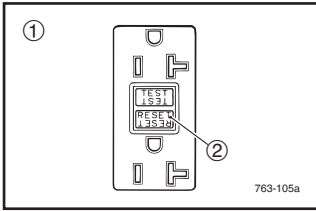

① G.F.C.I. (Ground Fault Circuit Interrupter)

② Reset button

③ Pops out

WARNING

TO REDUCE THE CHANCE OF ELECTRICAL SHOCK:

- Do not attempt to operate equipment if the ground fault circuit interrupter reset button pops out repeatedly during use.
- Test the ground fault circuit interrupter during the pre-operation checks according to the maintenance instructions on page 33.
- Remember that only receptacles labeled “GFCI” have ground fault circuit interrupter protection.

PREPARATION

AE00856

Fuel

WARNING

- Fuel is highly flammable and poisonous. Check “SAFETY INFORMATION” (See page 2) carefully before filling.
- Do not overfill the fuel tank, otherwise it may overflow when the fuel warms up and expands.
- After fill the fuel, make sure the fuel tank cap is tightened securely.

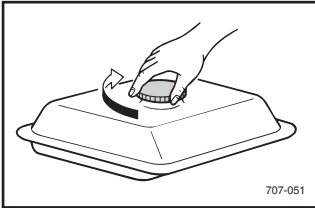
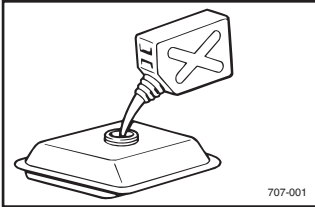

1. Stop the engine.
2. Place the generator on a level surface.
3. Remove the fuel tank cap.
4. Check the fuel level.
5. If low, fill the tank with fuel.

NOTICE

- Immediately wipe off spilled fuel with a clean, dry, soft cloth, since fuel may deteriorate painted surfaces or plastic parts.
- Use only unleaded gasoline. The use of leaded gasoline will cause severe damage to internal engine parts.

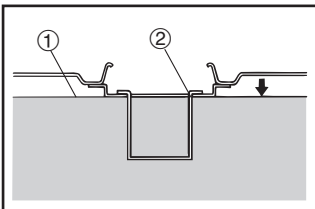

Make sure there is sufficient fuel in the tank. When refueling, be sure to fill the tank up to the bottom edge of the fuel tank filter.

- ① Fuel level
- ② Fuel tank filter
- ③ Fuel level gauge
- ④ Bottom edge of the fuel tank filter

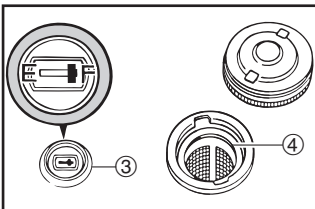

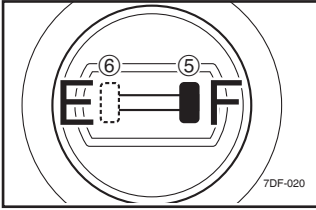

Recommended fuel:
 Unleaded gasoline
 Fuel tank capacity:
 Total:
 9.7 L (2.56 US gal, 2.13 Imp gal)

⑤ "F"	Full
⑥ "E"	Empty

Your Kohler engine has been designed to use regular unleaded gasoline with a pump octane number ((R + M)/2) of 86 or higher, or research octane number of 91 or higher.

AE00222

Engine oil

NOTICE

The generator has been shipped without engine oil. Do not start the engine until you have filled it with the sufficient engine oil.

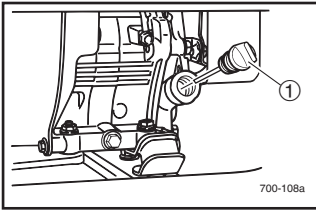

1. Place the generator on a level surface.
2. Remove the oil filler cap.

① Oil filler cap

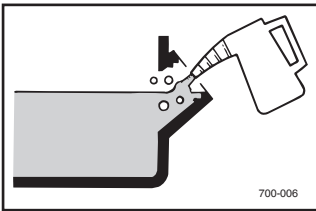

3. Fill the specified amount of the recommended engine oil, and then tighten the oil filler cap.

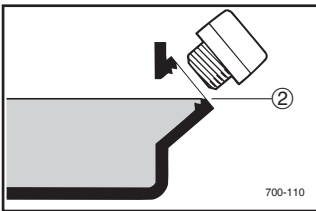

② Correct level

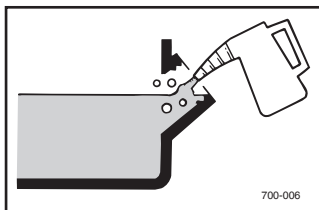
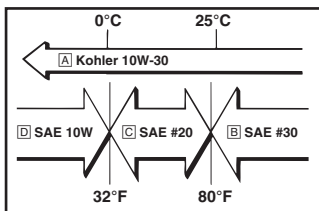

Recommended engine oil:

- A** Kohler 10W-30,
SAE 10W-30 or 10W-40
- B** SAE #30
- C** SAE #20
- D** SAE 10W

Recommended engine oil grade:

API Service SE type or higher

Engine oil quantity:

0.6 L (0.63 US qt, 0.53 Imp qt)

NOTICE

The generator has been shipped without engine oil. Do not start the engine till fill with the sufficient engine oil.

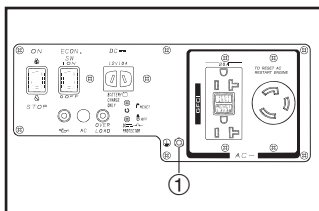

AE00241

Ground (earth) terminal

Make sure to Ground (earth) terminal the generator. Check "SAFETY INFORMATION" (see page 3).

- ① Ground (earth) terminal

PRE-OPERATION CHECK



If any item in the Pre-operation check is not working properly, have it inspected and repaired before operating the generator.

The condition of a generator is the owner's responsibility. Vital components can start to deteriorate quickly and unexpectedly, even if the generator is unused.

TIP

Pre-operation checks should be made each time the generator is used.

Pre-operation check

Fuel (See page 10)

- Check fuel level in fuel tank.
- Refuel if necessary.

Fuel line

- Check fuel hose for crack or damage.
- Replace if necessary.

Engine oil (See page 11)

- Check oil level in engine.
- If necessary, add recommended oil to specified level.
- Check generator for oil leakage.

The point where abnormality was recognized by use

- Check operation.
- If necessary, consult a Kohler portable dealer.

AE00955

OPERATION

WARNING

- Never operate the engine in a closed area or it may cause unconsciousness and death within a short time. Operate the engine in a well ventilated area.
- Before starting the engine, do not connect any electric devices.
- Clean dusts, dirt or water off the receptacle before use.

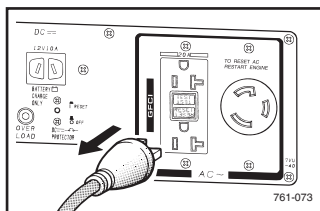

NOTICE

The generator has been shipped without engine oil. Do not start the engine till fill with the sufficient engine oil.

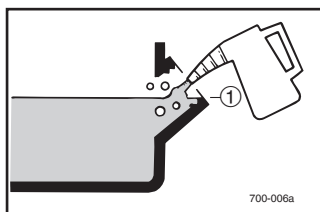

- ① Correct level

AE00989

Starting the engine

1. Turn the economy control switch to “○” (OFF).

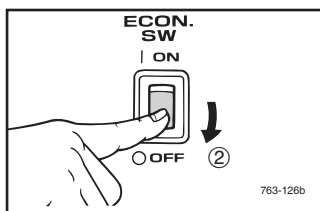

- ② “○” (OFF)

2. Turn the fuel cock lever to the ON position.

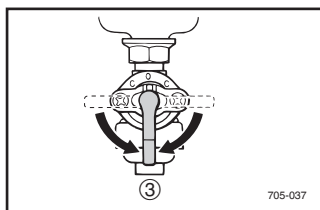

- ③ ON

3. Turn the engine switch to the “E” (ON) position.

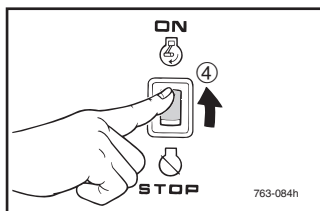

- ④ “E” (ON)

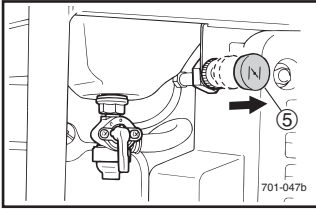

4. Pull the choke knob fully out.

⑤ Choke knob

TIP

The choke is not required to start a warm engine. Push the choke knob in to the original position.

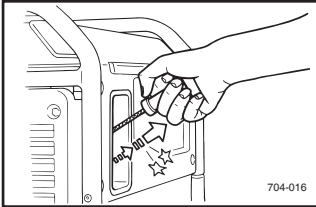

5. Pull the recoil starter slowly until it is engaged, then pull it briskly.

6. After the engine starts, warm up the engine until the engine does not stop when the choke knob is returned to the original position.

7. Push the choke knob back to the original position.

⑥ Original position

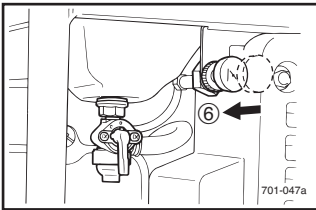





TIP

When starting the engine in areas where the ambient temperature is below 0°C (32°F), the engine automatically operates at the rated r/min (3,600 r/min) for three minutes to warm up the engine regardless of the economy control switch position. The economy control unit operates normally afterwards if the economy control switch is turned to "I" (ON).

Application range

When using the generator, make sure the total load is within rated output of a generator. Otherwise, generator damage may occur.

AC				DC 
Power factor	1	0.8–0.95	0.4–0.75 (Efficiency 0.85)	
PRO 2.8 i	–2,500 W	–2,000 W	–850 W	Rated voltage 12 V Rated current 10 A

TIP

- “–” means below.
- Application wattage indicates when each device is used by itself.
- The simultaneous usage of AC and DC power is possible but total wattage should not exceed the rated output.

EX:

Generator rated output		2,500 VA
Frequency	Power factor	
AC	1.0	–2,380 W
	0.8	–1,880 W
DC	—	120 W (12 V/10 A)

- The overload indicator light comes on when total wattage exceeds the application range. (See page 19 for more details.)

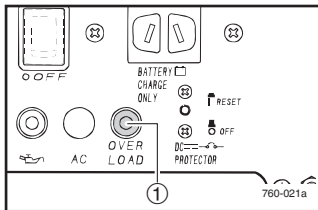

① Overload indicator light

NOTICE

- **Do not overload.** The total load of all electrical appliances must not exceed the supply range of the generator. Overloading will damage the generator.
 - **When supplying precision equipment, electronic controllers, PCs, electronic computers, microcomputer-based equipment or battery chargers, keep the generator a sufficient distance away to prevent electrical interference from the engine. Also ensure that electrical noise from the engine does not interfere with any other electrical devices located near the generator.**
 - **If the generator is to supply medical equipment, advice should first be obtained from the manufacturer, a medical professional or hospital.**
 - **Some electrical appliances or general-purpose electric motors have high starting currents, and cannot therefore be used, even if they lie within the supply ranges given in the above table. Consult the equipment manufacturer for further advice.**
-

High Altitude Operation

This engine may require a high altitude carburetor kit to ensure correct engine operation at altitudes above 4000 ft. (1219 meters). If you operate your engine at altitudes above 4000 ft. (1219 meters) consistently, have your local Kohler portable dealer perform the necessary carburetor modification. This engine should be operated in its original configuration below 4000 ft. (1219 meters) as damage may occur if high altitude carburetor kit is installed and operated below 4000 ft. (1219 meters).

Connection Alternating Current (AC)

⚠ WARNING

Be sure any electric devices are turned off before plugging them in.

NOTICE

- Be sure all electric devices including the lines and plug connections are in good condition before connection to the generator.
- Be sure the total load is within generator rated output.
- Be sure the receptacle load current is within receptacle rated current.

1. Start the engine.

2. Plug into the AC receptacle.

3. Make sure the AC pilot light (green) is on.

① AC pilot light (green)

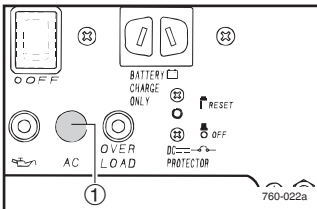
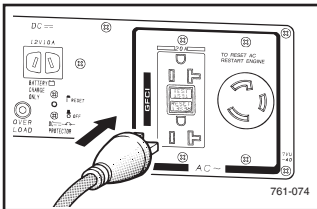

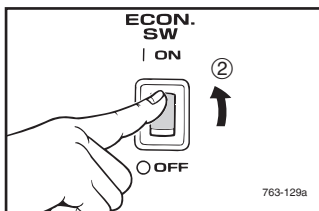

4. Turn the economy control switch to "I" (ON) and turn on any electric devices.

② "I" (ON)

TIP

The economy control switch must be turned to "O" (OFF) when using electric devices that require a large starting current, such as a compressor or a submersible pump.

AE00788

Overload indicator light (red)

The overload indicator light (red) comes on when an overload of a connected electrical device is detected, the inverter control unit overheats, or the AC output voltage rises. The electronic breaker will then activate, stopping power generation in order to protect the generator and any connected electric devices. The AC pilot light (green) will go off and the overload indicator light (red) will stay on, but the engine will not stop running.

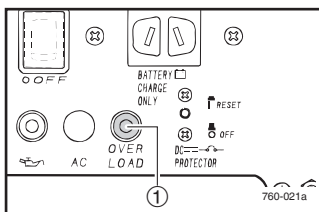

① Overload indicator light (red)

When the overload indicator light comes on and power generation stops, proceed as follows:

1. Turn off any connected electric devices and stop the engine.
2. Reduce the total wattage of connected electric devices within the application range.
3. Check for blockages in the cooling air inlet and around the control unit. If any blockages are found, remove them.
4. After checking, restart the engine.

TIP

- The generator AC output automatically resets when the engine is stopped and then restarted.
- The overload indicator light may come on for a few seconds at first when using electric devices that require a large starting current, such as a compressor or a submersible pump. However, this is not a malfunction.

Battery charging

NOTICE

- Do not connect a VRLA (Valve Regulated Lead Acid) battery. To charge a VRLA battery, a special (constant-voltage) battery charger is required.
- Do not use AC and DC power at the same time or the generator may be damaged.

TIP

- The generator DC rated voltage is 12 V.
- Start the engine first, and then connect the generator to the battery for charging.
- Before starting to charge the battery, make sure that the DC protector is turned **⬇** “I” (RESET).

1. Start the engine.

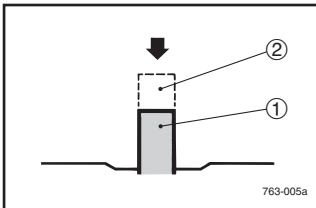

2. Press in the DC protector.

- ① **⬇** “I” (RESET)
- ② **⬆** “O” (OFF)

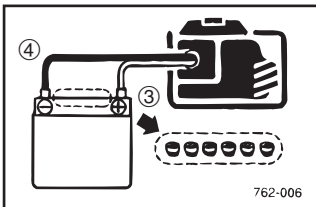

3. Connect the red battery charger lead to the positive (+) battery terminal.

- ③ Red wire
- ④ Black wire

4. Connect the black battery charger lead to the negative (-) battery terminal.

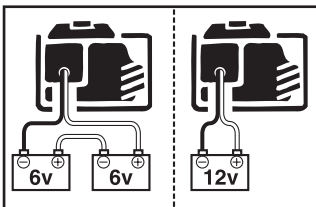

5. Turn the economy control switch “O” (OFF) to start battery charging.

NOTICE

- Be sure the economy control switch is turned off while charging the battery.
- Be sure to connect the red battery charger lead to the positive (+) battery terminal, and connect the black lead to the negative (-) battery terminal. Do not reverse these positions.
- Connect the battery charger leads to the battery terminals securely so that they are not disconnected due to engine vibration or other disturbances.
- Charge the battery in the correct procedure by following instructions in the owner's manual for the battery.
- The DC protector turns **■** "○" (OFF) automatically if current above the rated flows during battery charging.

To restart charging the battery, turn the DC protector on by pressing its button to **■** "I" (RESET). If the DC protector turns off again, stop charging the battery immediately and consult a Kohler portable dealer.

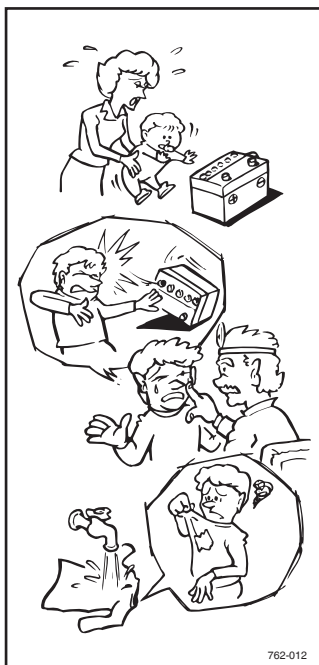

TIP

- Follow instructions in the owner's manual for the battery to determine the end of battery charging.
- Measure the specific gravity of electrolyte to determine if the battery is fully charged. At full charge, the electrolyte specific gravity is between 1.26 and 1.28.
- It is advisable to check the specific gravity of the electrolyte at least once every hour to prevent overcharging the battery.

! WARNING

Never smoke or make and break connections at the battery while charging. Sparks may ignite the battery gas.

Battery electrolyte is poisonous and dangerous, causing severe burns, etc. contains sulfuric (sulphuric) acid. Avoid contact with skin, eyes or clothing.

Antidote:

EXTERNAL-Flush with water.

INTERNAL-Drink large quantities of water or milk. Follow with milk of magnesia, beaten egg or vegetable oil. Call physician immediately.

EYES: Flush with water for 15 minutes and get prompt medical attention. Batteries produce explosive gases. Keep sparks, flame, cigarettes, etc., away. Ventilate when charging or using in closed space. Always cover eyes when working near batteries. KEEP OUT OF REACH OF CHILDREN.

Operating range of DC power supply (exclusively for charging 12 V battery)

This power source is designed to charge batteries up to 40 Ah that are half-discharged. Do not charge batteries of a higher capacity than 40 Ah.

12 V battery

The time required for recharging a battery varies depending on the discharge level of the battery. When the specific gravity of the battery reaches 1.26 to 1.28, charging is complete. When charging, check the battery's specific gravity once an hour.

The average time for charging a half-discharged 40 Ah battery is approximately 5 hours. Be sure to check the battery fluid level before charging.

NOTICE

- **Do not connect any load to the battery or use the engine starter motor while charging. This causes high current to flow through the generator which will burn out the coil.**
 - **Do not connect a VRLA (Valve Regulated Lead Acid) battery. To charge a VRLA battery, a special (constant-voltage) battery charger is required.**
-

Stopping the engine

1. Turn off any electric devices.

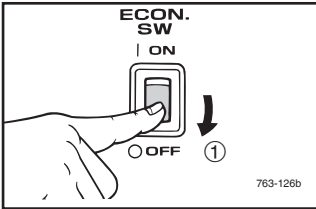

2. Turn the economy control switch to the “○” (OFF) position.

① “○” (OFF)

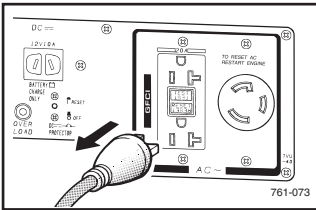

3. Disconnect any electric devices.

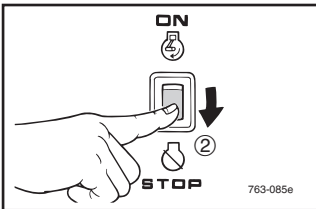

4. Turn the engine switch to the “⊘” (STOP) position.

② “⊘” (STOP)

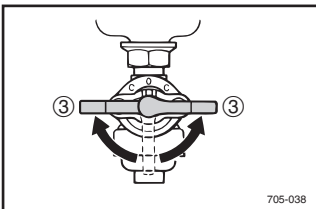

5. Turn the fuel cock lever to OFF.

③ OFF

PERIODIC MAINTENANCE

Safety is an obligation of the owner. Periodic inspection, adjustment and lubrication will keep your generator in the safest and most efficient condition possible. The most important points of generator inspection, adjustment, and lubrication are explained on the following pages.



WARNING

If you are not familiar with maintenance work, have a Kohler portable dealer do it for you.

Maintenance chart



WARNING

Stop the engine before starting maintenance work.

NOTICE

Use only Kohler specified genuine parts for replacement. Ask an authorized Kohler portable dealer for further attention.

Item	Routine	Pre-operation check	Every	
			6 months or 100 Hr	12 months or 300 Hr
Spark plug	<ul style="list-style-type: none"> • Check condition. • Clean and replace if necessary. 		○	
Fuel	<ul style="list-style-type: none"> • Check fuel level and leakage. 	○		
Fuel hose	<ul style="list-style-type: none"> • Check fuel hose for cracks or damage. Replace if necessary. 	○		
Engine oil	<ul style="list-style-type: none"> • Check oil level in engine. 	○		
	<ul style="list-style-type: none"> • Replace. 		○(*1)	
Air filter element	<ul style="list-style-type: none"> • Check condition. • Clean. 		○(*2)	
Muffler screen	<ul style="list-style-type: none"> • Check condition. • Clean and replace if necessary. 		○	
Spark arrester	<ul style="list-style-type: none"> • Check condition. • Clean and replace if necessary. 		○	
Fuel tank filter	<ul style="list-style-type: none"> • Clean and replace if necessary. 			○
Fuel strainer	<ul style="list-style-type: none"> • Clean and replace if necessary. 			○

Item	Routine	Pre-operation check	Every	
			6 months or 100 Hr	12 months or 300 Hr
Crankcase breather hose	<ul style="list-style-type: none"> • Check breather hose for cracks or damage. • Replace if necessary. 			○
Cylinder head	<ul style="list-style-type: none"> • Decarbonize cylinder head. • More frequently if necessary. 	After every 500 Hrs.		
Valve clearance	<ul style="list-style-type: none"> • Check and adjust when engine is cold. 			★
Idle speed	<ul style="list-style-type: none"> • Check and adjust idle speed. 			★
Recoil starter	<ul style="list-style-type: none"> • Check recoil starter for damage. 			★
Fittings / fasteners	<ul style="list-style-type: none"> • Check all fittings and fasteners. • Correct if necessary. 			★
The point where abnormality was recognized by use.		○		

*1Initial replacement of the engine oil is after one month or 20 hours of operation.

*2The air filter element needs to be cleaned more frequently when using in unusually wet or dusty areas.

★.....Since these items require special tools, data and technical skills, have a Kohler portable dealer perform the service.

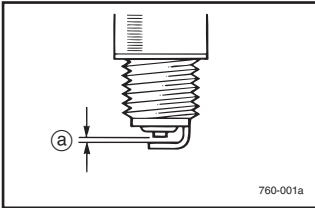
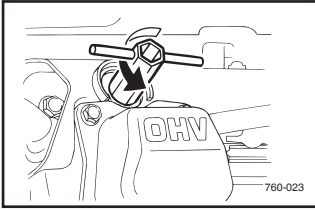

Spark plug inspection

The spark plug is an important engine components, which should be checked periodically.

1. Remove the spark plug cap.
2. Insert the tool, and turn it counterclockwise to remove the spark plug.
3. Check for discoloration and remove the carbon. The porcelain insulator around the center electrode of spark plug should be a medium-to-light tan color.
4. Check the spark plug type and gap.

Ⓐ Spark plug gap

Standard spark plug:
33 132 01-S (Kohler)
Spark plug gap:
0.7–0.8 mm (0.028–0.031 in)

TIP

The spark plug gap should be measured with a wire thickness gauge and, if necessary, adjusted to specification.

5. Install the spark plug and then tighten it.

Spark plug tightening torque:
18 Nm (1.8 m·kgf, 13 ft·lbf)

TIP

If a torque wrench is not available when installing a spark plug, a good estimate of the correct torque is 1/4–1/2 turn past finger tight. However, the spark plug should be tightened to the specified torque as soon as possible.

6. Install the spark plug cap.

AE00431

Carburetor adjustment

The carburetor is a vital part of the engine. Adjusting should be left to a Kohler portable dealer with the professional knowledge, specialized data, and equipment to do so properly.

Engine oil replacement

⚠ WARNING

Avoid draining the engine oil immediately after stopping the engine. The oil is hot and should be handled with care to avoid burns.

1. Place the generator on a level surface and warm up the engine for several minutes.
Then stop the engine.

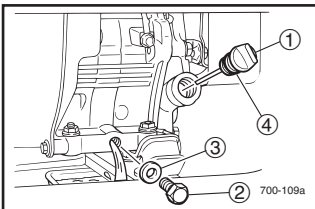

2. Remove the oil filler cap.

① Oil filler cap

3. Place an oil pan under the engine. Remove the oil drain bolt and gasket so that the oil can be completely drained.

② Oil drain bolt

③ Gasket

4. Check the oil drain bolt, oil filler cap and O-ring.
Replace them if damaged.

④ O-ring

5. Install a new gasket and the oil drain bolt, and then tighten the bolt.

Oil drain bolt tightening torque:
17 Nm (1.7 m·kgf, 12 ft·lbf)

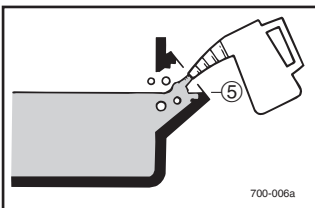

6. Add engine oil to the correct level.

NOTICE

Be sure no foreign material enters the crankcase.

⑤ Correct level

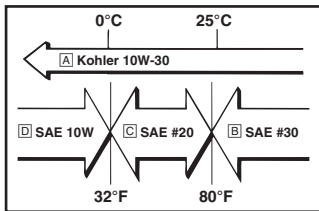

Recommended engine oil:

- A Kohler 10W-30,
SAE 10W-30 or 10W-40
- B SAE #30
- C SAE #20
- D SAE 10W

Recommended engine oil grade:
API Service SE type or higher

Engine oil quantity:
0.6 L (0.63 US qt, 0.53 Imp qt)

7. Install the O-ring and the oil filler cap.



AE00443

Muffler screen and spark arrester



The engine and muffler will be very hot after the engine has been run.

Avoid touching the engine and muffler while they are still hot with any part of your body or clothing during inspection or repair.

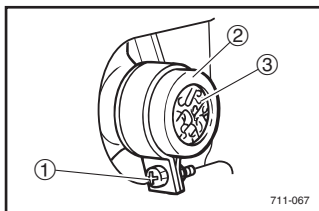

1. Loosen the muffler cap bolt and then remove the muffler cap and muffler screen.

- ① Muffler cap bolt
- ② Muffler cap
- ③ Muffler screen

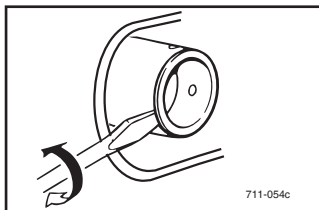

2. Use a flathead screw driver to pry the spark arrester out from the muffler.

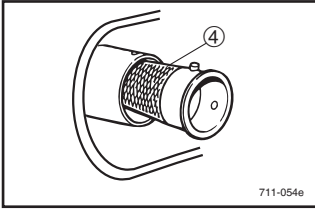

3. Remove the spark arrester.

④ Spark arrester

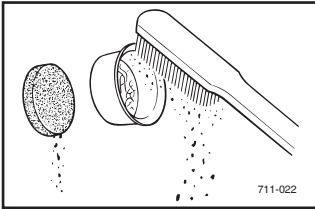

4. Remove the carbon deposits on the muffler screen, muffler cap and spark arrester using a wire brush.

NOTICE

When cleaning, use the wire brush lightly to avoid damaging or scratching of the muffler screen, muffler cap and spark arrester.

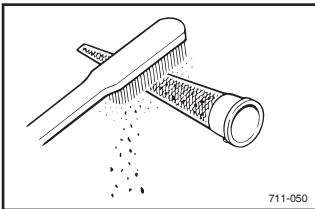

5. Check the muffler screen and spark arrester. Replace them if damaged.

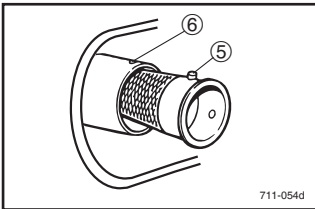

6. Install the spark arrester.

TIP

Align the spark arrester lump to the hole in the muffler pipe.

⑤ Spark arrester lump

⑥ Hole

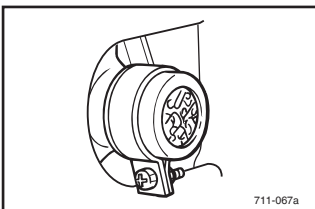

7. Install the muffler screen and muffler cap, and then tighten the muffler cap bolt.

Muffler cap bolt tightening torque:
3.5 Nm (0.35 m-kgf, 2.5 ft-lbf)

Air filter

1. Remove the screws, and then remove the air filter case cover.

2. Remove the foam element.

- ① Screw
- ② Air filter case cover
- ③ Foam element

3. Wash the foam element in solvent and dry it.

WARNING

Never use solvent while smoking or in the vicinity of an open flame.

4. Oil the foam element and squeeze out excess oil. The foam element should be wet but not dripping.

NOTICE

Do not wring out the foam element when squeezing it. This could cause it to tear.

Recommended oil:

Foam-air-filter oil or engine oil (See page 29)

5. Insert the foam element into the air filter case.

NOTICE

The engine should never run without the foam element; excessive piston and cylinder wear may result.

TIP

Be sure the foam element sealing surface matches the air filter so there is no air leak.

6. Install the air filter case cover and tighten the screws.

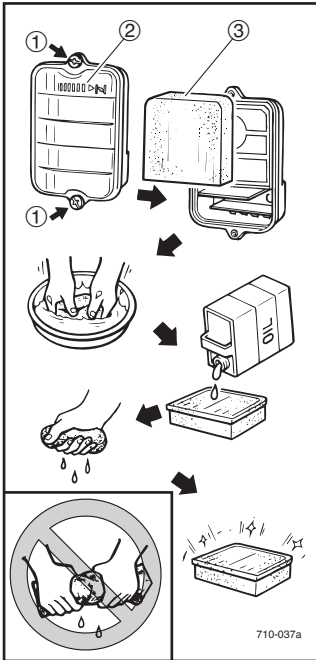

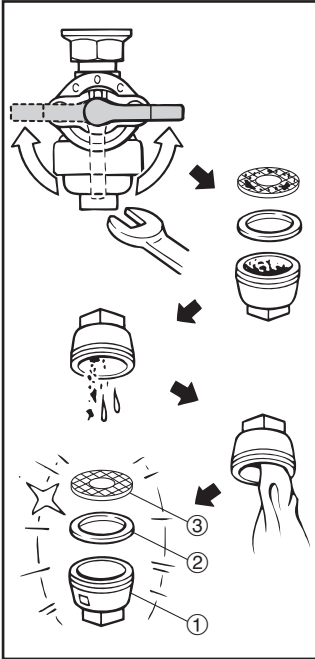

Fuel cock

⚠ WARNING

Never use the gasoline while smoking or in the vicinity of an open flame.

1. Stop the engine.
2. Turn the fuel cock lever to OFF.
3. Remove the fuel cock cup, gasket and fuel strainer.
4. Clean the cup and fuel strainer with gasoline and wipe it off.
5. Check the gasket. Replace it if damaged.
6. Install the fuel strainer, gasket, and fuel cock cup.

⚠ WARNING

Be sure the fuel cock cup is tightened securely.

- ① Fuel cock cup
- ② Gasket
- ③ Fuel strainer

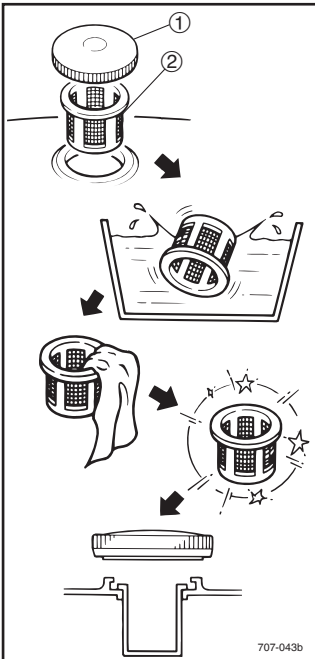

Fuel tank filter

⚠ WARNING

Never use the gasoline while smoking or in the vicinity of an open flame.

1. Remove the fuel tank cap and fuel tank filter.

- ① Fuel tank cap
- ② Fuel tank filter

2. Clean the fuel tank filter with gasoline. Replace it if damaged.
3. Wipe the fuel tank filter and insert it.
4. Install the fuel tank cap.

⚠ WARNING

Be sure the fuel tank cap is tightened securely.

AE01007

G.F.C.I. Receptacle test

1. Start the engine.
2. Press the test button, then check the position of the reset button.

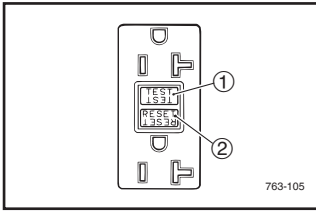

- ① Test button
- ② Reset button

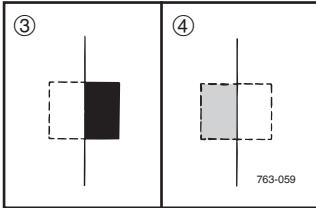

G.F.C.I. Reset Button Position after Test	G.F.C.I. Receptacle Operation
③ Pop Out	Correct
④ Stay In	Incorrect

3. If G.F.C.I. operation is correct, push in the reset button.
If the G.F.C.I. operates incorrectly, consult a Kohler portable dealer.

WARNING

Do not operate the generator with a faulty G.F.C.I. circuit. Electric shock could occur. Have the generator repaired by a qualified mechanic.

TROUBLESHOOTING

Engine won't start

1. Fuel systems

No fuel supplied to combustion chamber.

- No fuel in tank Supply fuel.
- Fuel in tank Fuel cock lever to ON.
- Clogged fuel line Clean fuel line.
- Foreign matter in fuel cock Clean fuel cock.
- Clogged carburetor Clean carburetor.

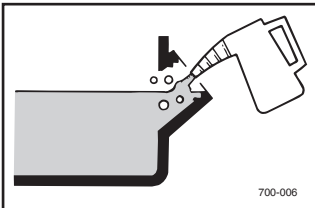
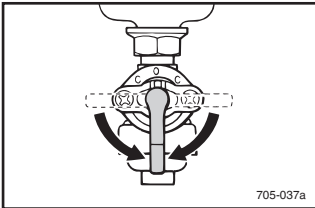
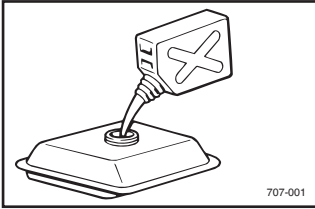

2. Engine oil system

Insufficient

- Oil level is low Add engine oil.

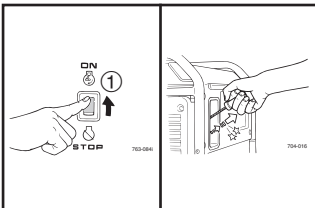

3. Electrical systems

- Engine switch to “**1**” (ON) and pull the recoil starter.

① “**1**” (ON)

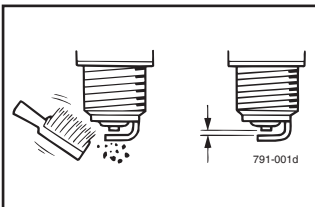

Poor spark

- Spark plug dirty with carbon or wet Remove carbon or wipe spark plug dry.
- Faulty ignition system Consult a Kohler portable dealer.

Generator won't produce power

- Safety device (AC) to OFF Stop the engine, then restart.
- Safety device (DC protector) to **0** “**0**” (OFF) Press to **I** “**I**” (RESET) the DC protector.

A ENGINE DOES NOT START

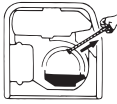
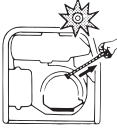

B Turn the engine switch to "I" (ON), then pull the recoil starter and check if the oil warning light flickers.

C Does not flicker	D Flickers
---------------------------	-------------------



H Pull the recoil starter and check the spark plug for spark strength. (See "WARNING")



⚠ WARNING

- To prevent **FIRE HAZARDS** be sure fuel is not present in the spark plug area.
- To prevent **FIRE HAZARDS** be sure to place the spark plug as far away as possible from the spark plug hole and carburetor area.
- To prevent **ELECTRIC SHOCK** do not hold spark plug lead with hand while testing.

I OK	J Does not spark
-------------	-------------------------



N Check the following.

- Fuel line clogging.
- Air filter element clogging.

O Clogged	P OK
------------------	-------------

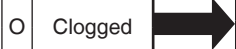

E Check engine oil level.

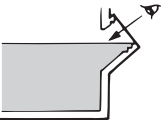
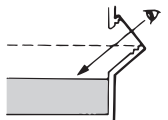
F OK	G Level low
Consult a Kohler portable dealer.	Add engine oil.

K Check the spark plug.

- Type: BPR4ES
- Gap: 0.7–0.8 mm (0.028–0.031 in)

L Incorrect	M OK
Replace or adjust gap.	Clean the spark plug.

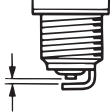
Q Clean or replace.	R OK
	S Engine does not start.



T Consult a Kohler portable dealer.

STORAGE

Long term storage of your generator will require some preventive procedures to guard against deterioration.

AE00611

Drain the fuel

1. Turn the engine switch to “” (STOP).

① “” (STOP)

2. Remove the fuel tank cap and fuel tank filter. Extract the fuel from the fuel tank into an approved gasoline container using a commercially available hand siphon. Then, install the fuel tank filter and fuel tank cap.

WARNING

Fuel is highly flammable and poisonous. Check “SAFETY INFORMATION” (See page 2) carefully.

NOTICE

Immediately wipe off spilled fuel with a clean, dry, soft cloth, since fuel may deteriorate painted surfaces or plastic parts.

3. Turn the engine switch to “” (ON).

② “” (ON)

4. Turn the fuel cock lever to ON.

③ ON

5. Start the engine and leave it run until it stops. The engine stops in approximately 20 minutes time by running out of fuel.

TIP

- Do not connect with any electrical devices. (unloaded operation)
- Duration of the running engine depends on the amount of the fuel left in the tank

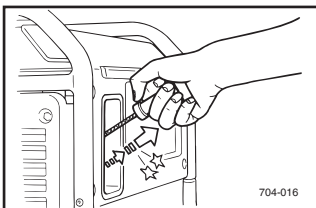
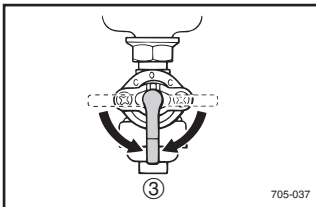
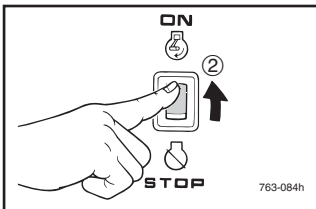
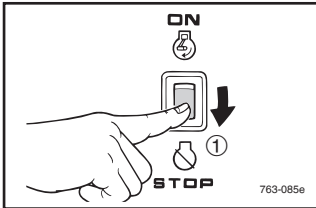

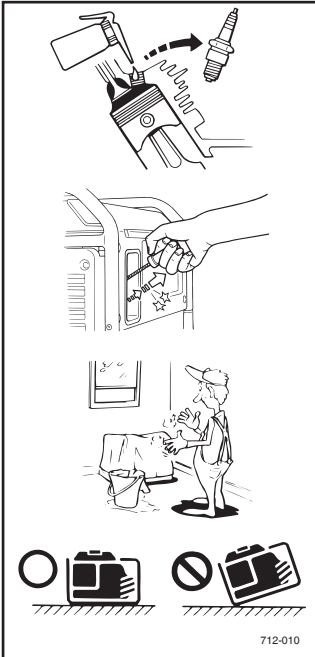
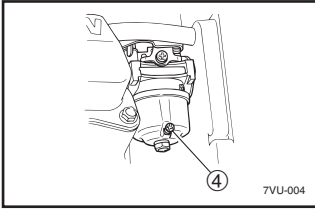

6. Drain the fuel remaining in the carburetor into an approved container by loosening the drain screw on the carburetor float chamber.

④ Drain screw

7. Tighten the drain screw.

8. Turn the engine switch to "⏻" (STOP).

9. Turn the fuel cock lever to OFF.

10. Tighten further if any screws, bolts and nuts are loose.

11. Store the generator in a dry, well-ventilated place, with the cover placed over it.

AE00621

Engine

Perform the following steps to protect the cylinder, piston ring, etc. from corrosion.

1. Remove the spark plug, pour about one tablespoon of engine oil (See page 12) into the spark plug hole and reinstall the spark plug only. Recoil start the engine by turning over several times (with ignition off) to coat the cylinder walls with oil.

2. Pull the recoil starter until you feel compression. Then stop pulling. (This prevents the cylinder and valve from rusting.)

3. Clean exterior of the generator and apply a rust inhibitor.

4. Store the generator in a dry, well-ventilated place, with the cover placed over it.

5. The generator must remain in a vertical position when stored, carried or operated.

EXHAUST EMISSION CONTROL SYSTEM AND COMPONENTS

Item	Acronym
• CARB. ASSY., LH. & JT., CARBURETOR2	CARB (Carburetor)
• C.D.I. UNIT ASSY. & C.D.I. MAGNETO ASSY. & PLUG, SPARK	EI (Electronic Ignition)
• CRANKCASE1 & HEAD, CYLINDER1	PCV (Positive Crankcase Ventilation)
• AIR FILTER ASSY.	ACL (Air Cleaner)
• MUFF., 2, CAP, NET, WIRE2 & ARRESTER, SPARK	

The above items and the corresponding acronyms are provided in accordance with U.S. EPA REGULATIONS FOR NEW NONROAD SPARK-IGNITION NONHANDHELD ENGINES and the CALIFORNIA REGULATIONS FOR 1995 AND LATER SMALL OFF-ROAD ENGINES.

The acronyms conform to the latest version of the SAE's recommended practice document J1930, "Diagnostic Acronyms, Terms, and Definitions For Electrical/Electronic System".

It is recommended that these items be serviced by a Kohler portable dealer.

SPECIFICATIONS

Dimensions

	Unit	PRO 2.8 i
Overall length	mm (in)	487 (19.2)
Overall width	mm (in)	395 (15.6)
Overall height	mm (in)	425 (16.7)
Dry weight	kg (lb)	31 (66.1)

Engine

	Unit	PRO 2.8 i
Type		Air cooled 4-stroke gasoline OHV
Cylinder arrangement		Inclined, 1 cylinder
Displacement	cm ³	171
Bore × Stroke	mm (in)	66.0 × 50.0 (2.60 × 1.97)
Operation hours	Hr	6.7–14.7 (rated load–1/4 load)
Fuel		Unleaded gasoline
Fuel tank capacity	L (US gal, Imp gal)	9.7 (2.55, 2.12)
Engine oil quantity	L (US qt, Imp qt)	0.6 (0.63, 0.53)
Ignition system		CDI
Spark plug: Type		33 132 01-S (Kohler)
Gap	mm (in)	0.7–0.8 (0.028–0.031)
Noise level*	dB / L _{WA}	94
	dB (A) / 7 m	65–68

* : Noise level is measured when the economy control switch is turned to ON.

L_{WA} shows the sound power level under the ISO3744 satisfied test conditions.

The noise level in “dB (A) / 7 m” is the arithmetic mean value in four directions measured 7 meters away from each side of the generator.

The noise level may vary in different environments.

Generator

	Unit	PRO 2.8 i
AC Output		
Rated voltage	V	120
Rated frequency	Hz	60
Rated current	A	20.8
Rated output	kVA	2.5
Safety device: Type		Electronic
DC Output		
Rated voltage	V	12
Rated current	A	10
Safety device: Type		DC protector

CONSUMER INFORMATION

SERIAL NUMBER:

<p>MODEL</p> <input type="text"/>
<p>SERIAL No.</p> <input type="text"/>

AE00012

Identification number records

Record your serial number in the spaces provided, to assist you in ordering spare parts from a Kohler portable dealer.

Also record and keep the serial number in a separate place in case your machine is stolen.

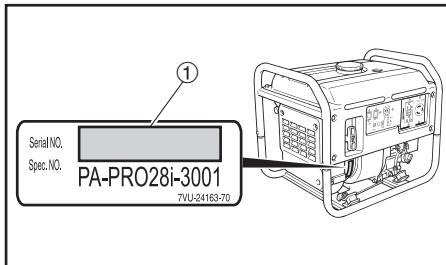

AE00011

Machine identification

The machine serial number is stamped in the location as shown.

① Machine serial number

TIP

Keep a record of serial number for reference when ordering parts from a Kohler portable dealer.

WIRING DIAGRAM

PRO 2.8 i

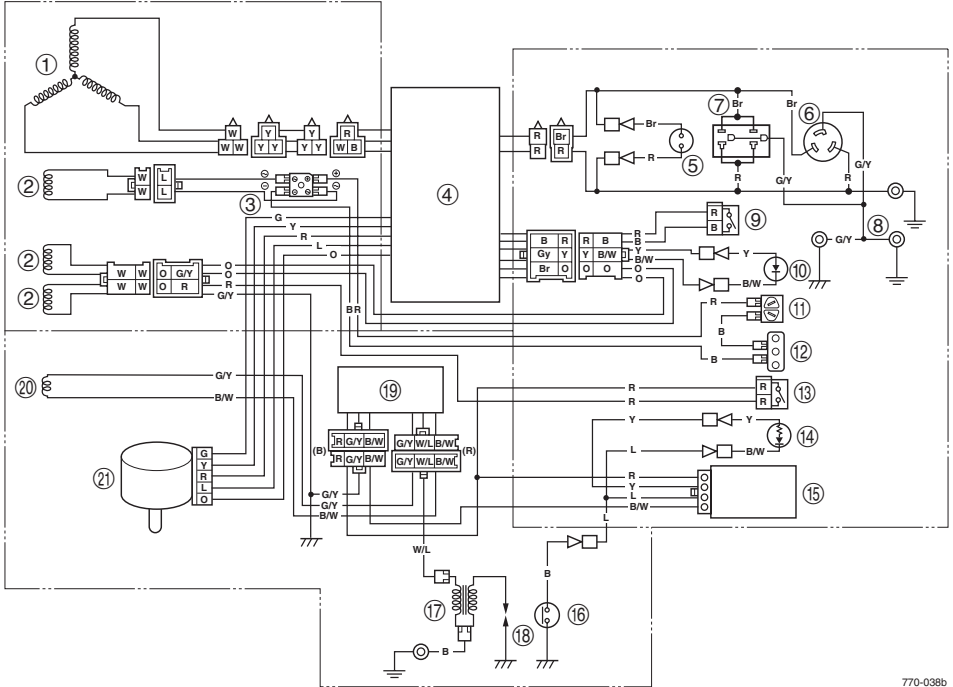

770-038b

- ① Main coil
- ② Sub coil
- ③ DC rectifier
- ④ Control unit
- ⑤ AC pilot light
- ⑥ AC receptacle
- ⑦ G.F.C.I. receptacle
- ⑧ Ground (earth) terminal
- ⑨ Economy control switch
- ⑩ Overload indicator light
- ⑪ DC receptacle
- ⑫ DC protector
- ⑬ Engine switch
- ⑭ Oil warning light
- ⑮ Oil warning unit
- ⑯ Oil level gauge
- ⑰ Ignition coil
- ⑱ Spark plug
- ⑲ AC-CDI unit
- ⑳ Pulser coil
- ㉑ Stepping motor

Color code

B	Black
Br	Brown
G	Green
Gy	Gray
L	Blue
O	Orange
R	Red
W	White
Y	Yellow
B/W	Black/White
G/Y	Green/Yellow
W/L	White/Blue

KOHLER[®]

PRINTED ON RECYCLED PAPER

PRINTED IN JAPAN
2014.01-0.1×1 
(E)